



V1.2 2025.01.08

GOODBYE

.....	3
.....	3
.....	3
.....	3
.....	4
.....	4
.....	5
.....	5
.....	6
.....	6
.....	7
.....	7
.....	7
.....	9
.....	10
.....	10
.....	11
.....	11
.....	13
.....	14
.....	15
.....	16
.....	16
.....	16

.....	17
.....	18
.....	18
.....	22
.....	22
.....	22
.....	24
.....	24
.....	25
.....	26
.....	27
.....	28
.....	31
.....	31
.....	31
.....	32
.....	32
.....	33
.....	33
.....	33
.....	34
.....	34
.....	34
.....	34
.....	39
.....	41









<ul style="list-style-type: none">•••••••••••••
<hr/>





-
-







-
-



-
-
-

		
	 15min	
		

<ul style="list-style-type: none">••	

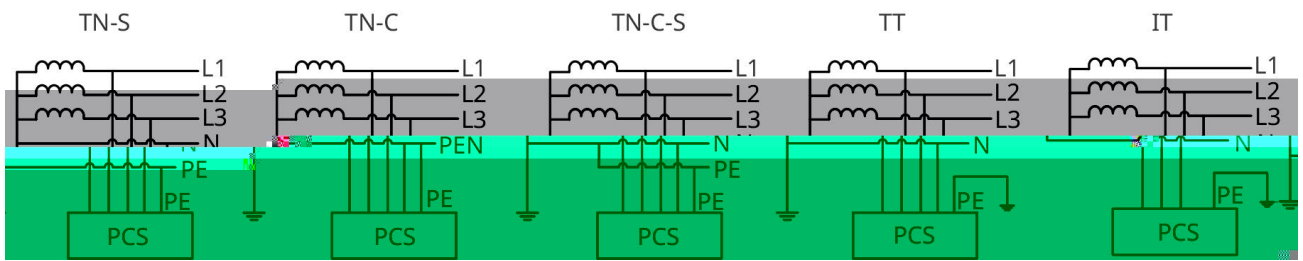

:

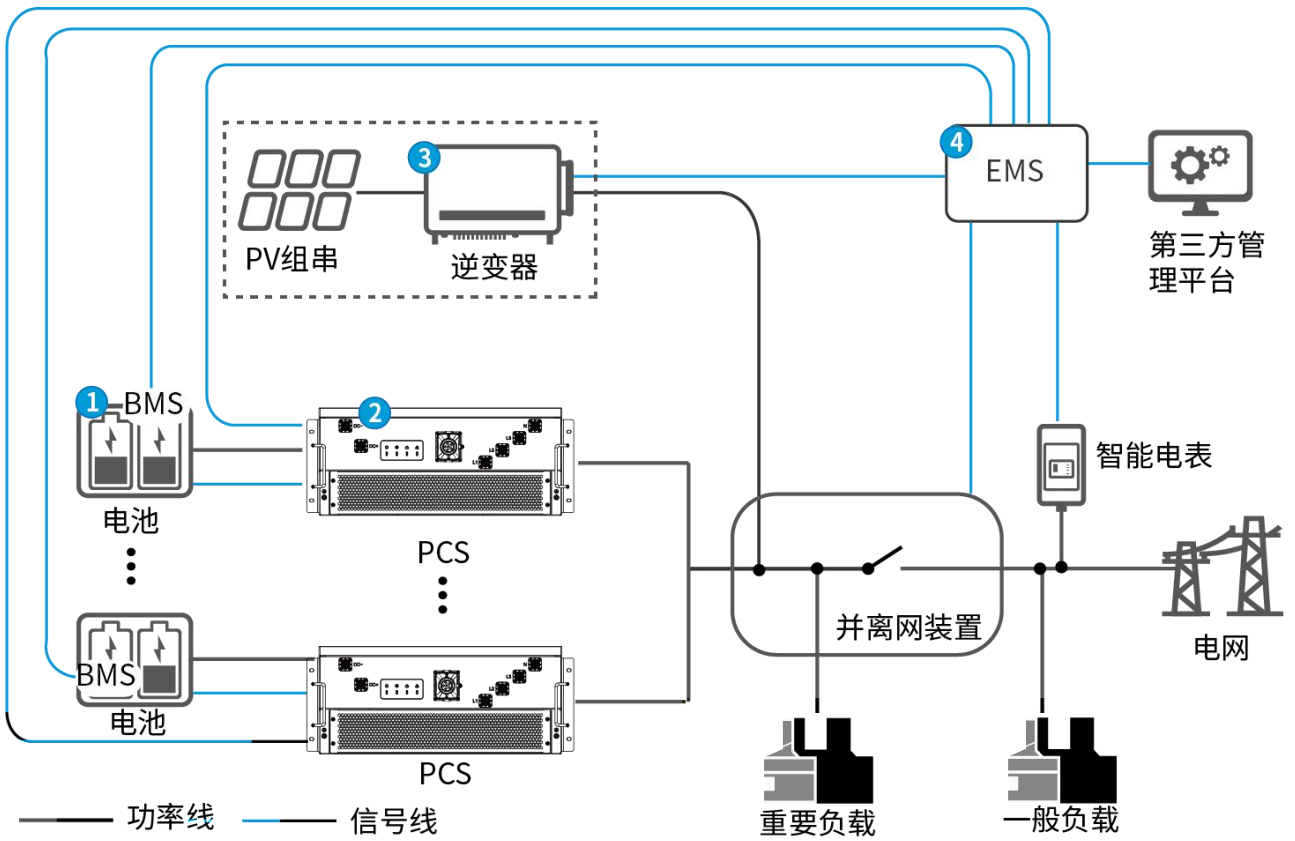

BTH10NET0001

		<ul style="list-style-type: none"> • •

--	--	--

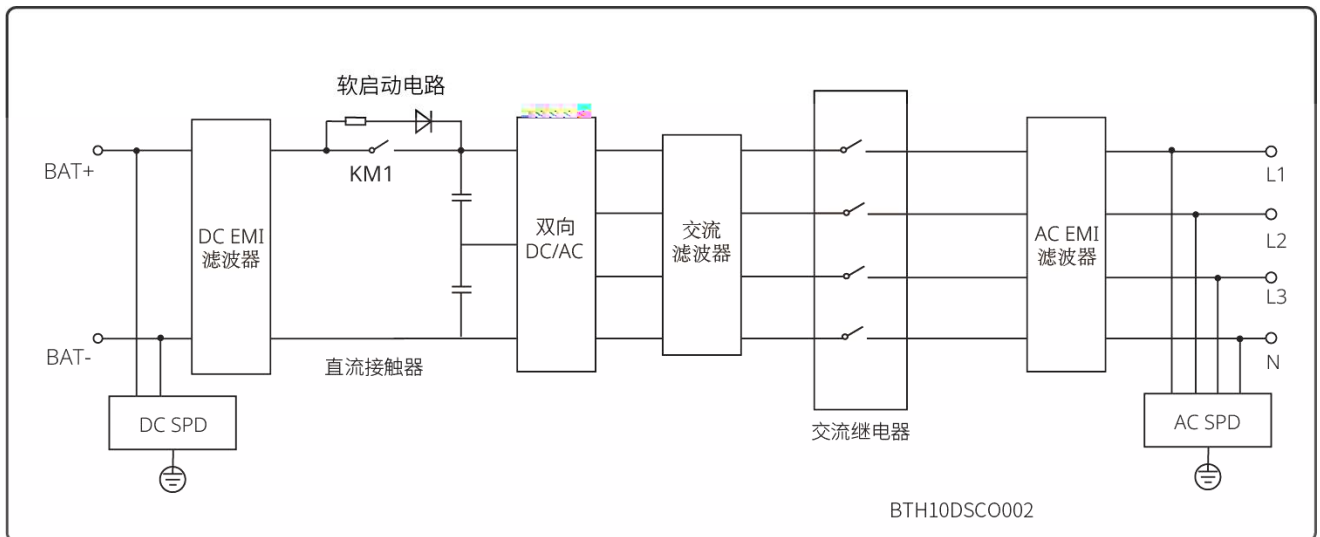
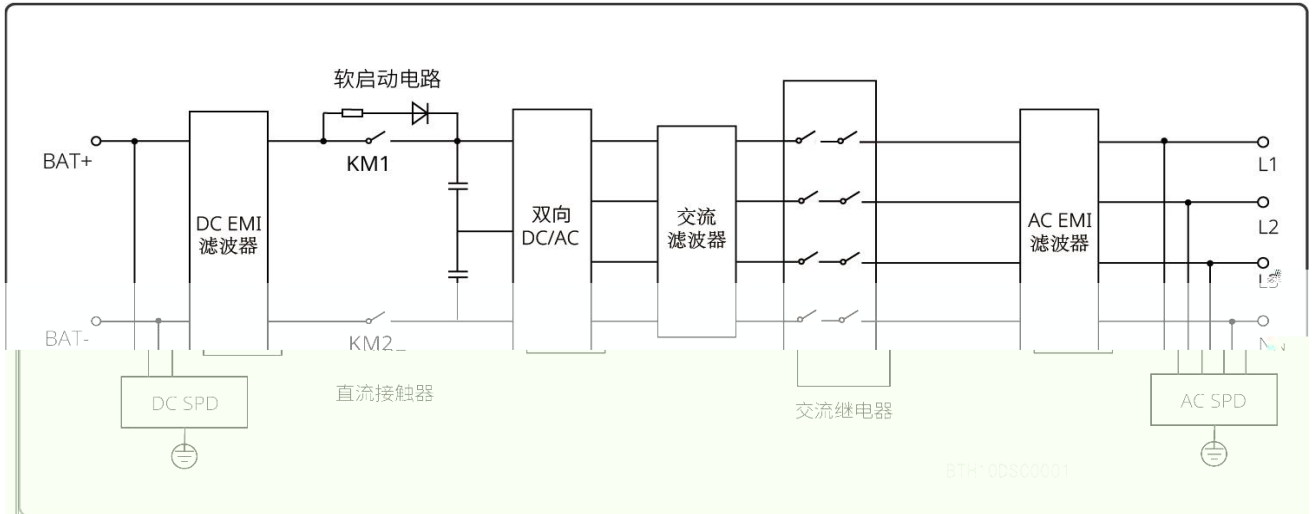

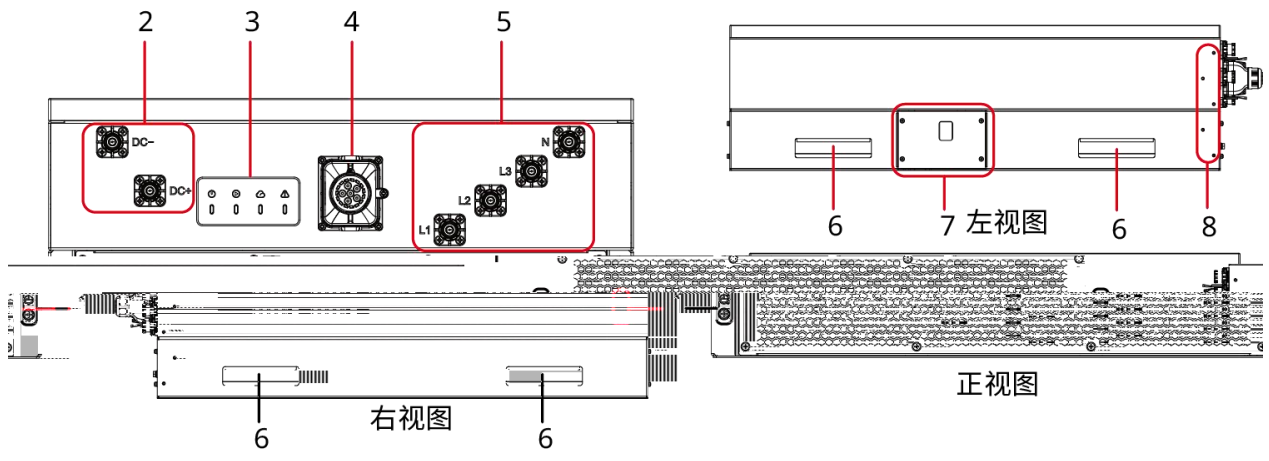

BTH10DSC0004

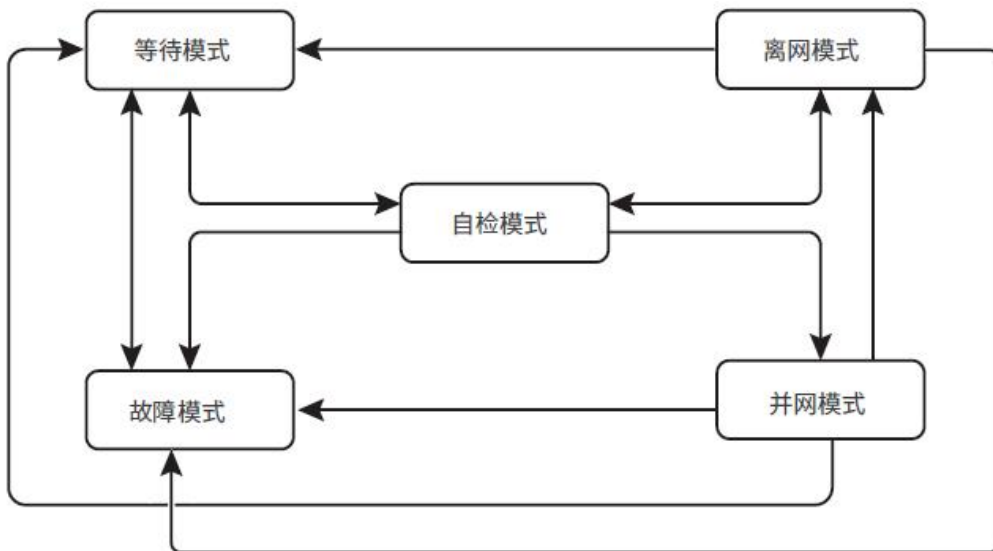
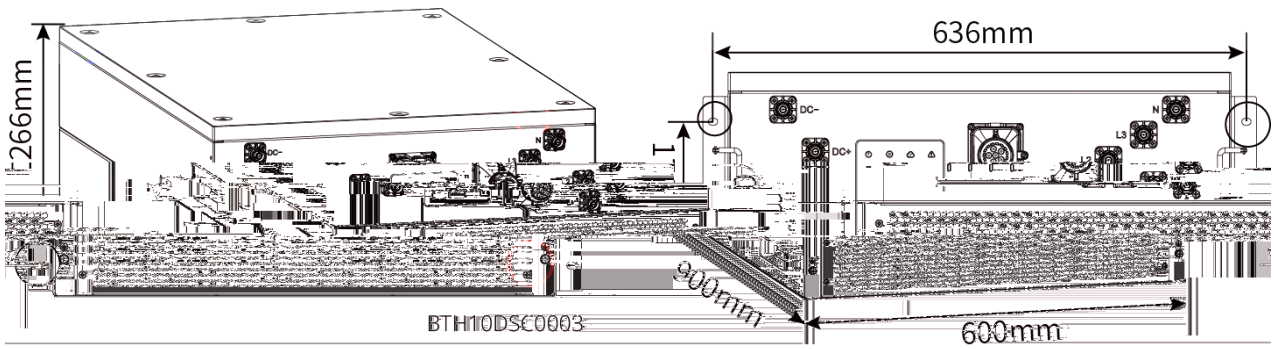

		<ul style="list-style-type: none"> • •
		<ul style="list-style-type: none"> • • •

		<ul style="list-style-type: none">•••
		<ul style="list-style-type: none">•••

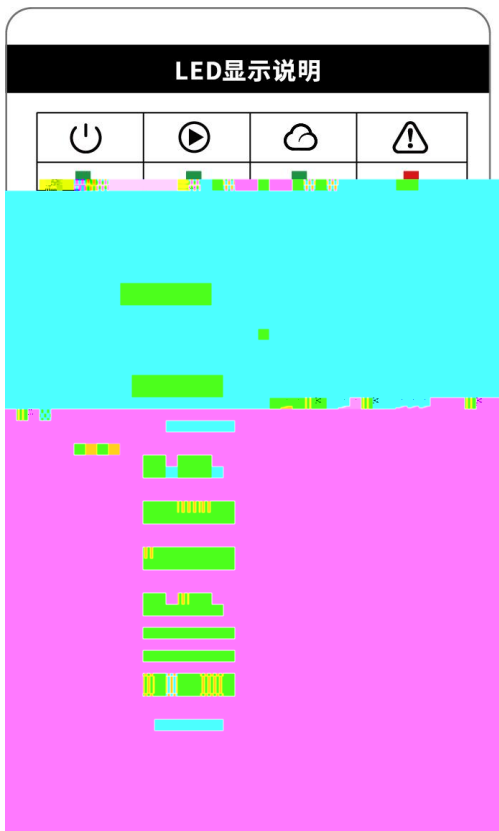

GOODWE
固德威

名称:储能变流器

型号:*****_***_*_***

—— 商标及产品类型和型号

直流输入

电池类型: 锂离子电池

最大持续充放电电流: *** * A.d.c.

直流电压范围: ***_****Vd.c.

交流输出

额定输出电压: 3L/N/PE^{220V}/*/*/* Va.c.

额定输出功率: *** kW

输出电压频率: **Hz

最大并网输出电流: *** * A.a.c.

额定并网输出电流: *** * A.a.c.

—— 产品技术参数

额定并网输出电流: *** * A.a.c.
额定并网输出功率: *** kW
输出电压频率: **Hz
输出电压范围: ***_****Vd.c.
最大持续充放电电流: *** * A.d.c.



-
-
-
-

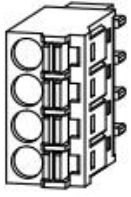
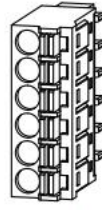

•
•



-25~+60°C



0%-100%RH

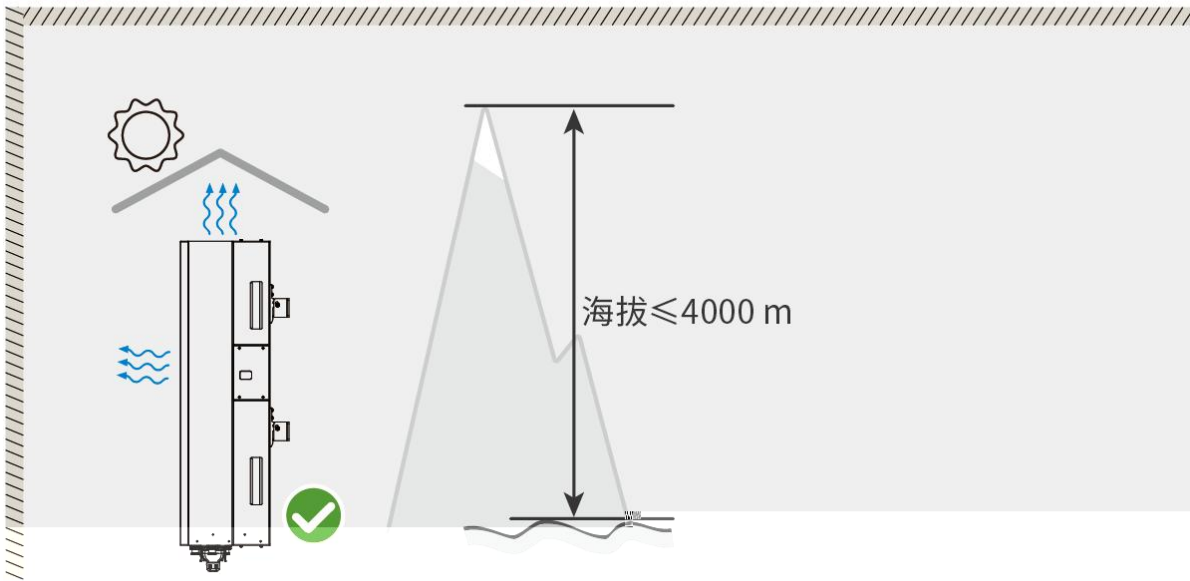

BTH10SYB0001

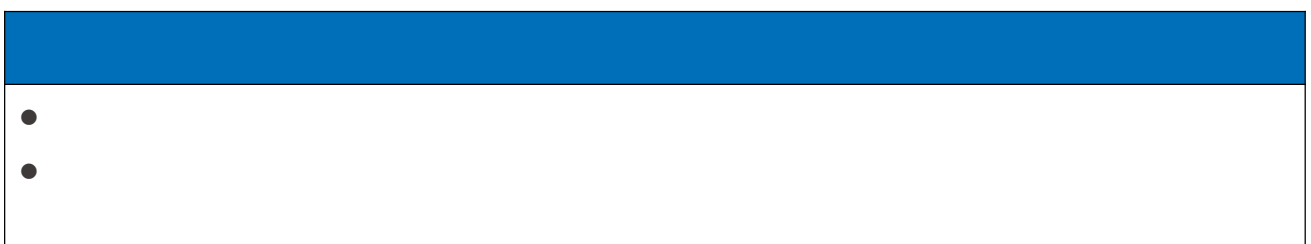
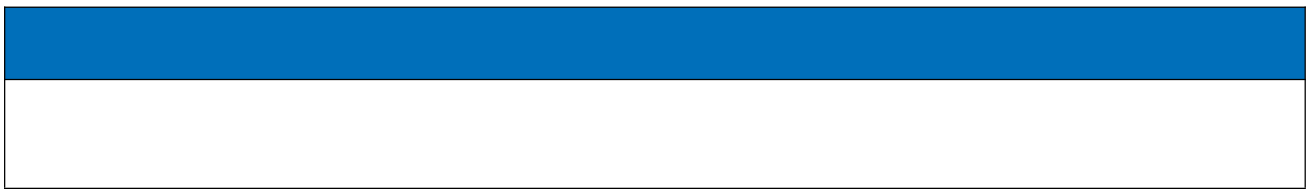

				
				
斜口钳	剥线钳	M6 M4 力矩扳手	扎线带	液压钳
				
水晶压线钳	管型端子压线钳	热缩套管	热风枪	

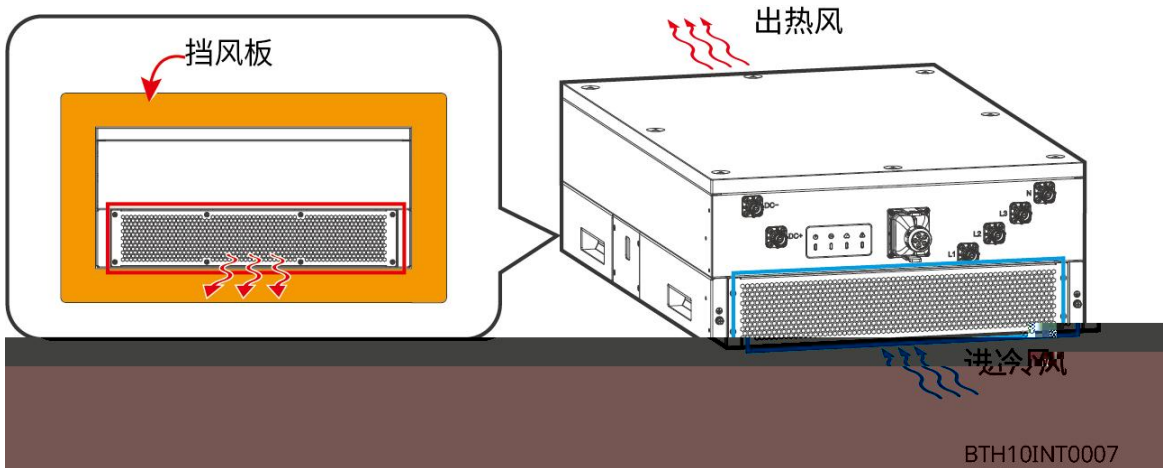



-
-
-
-
-

-
-
-

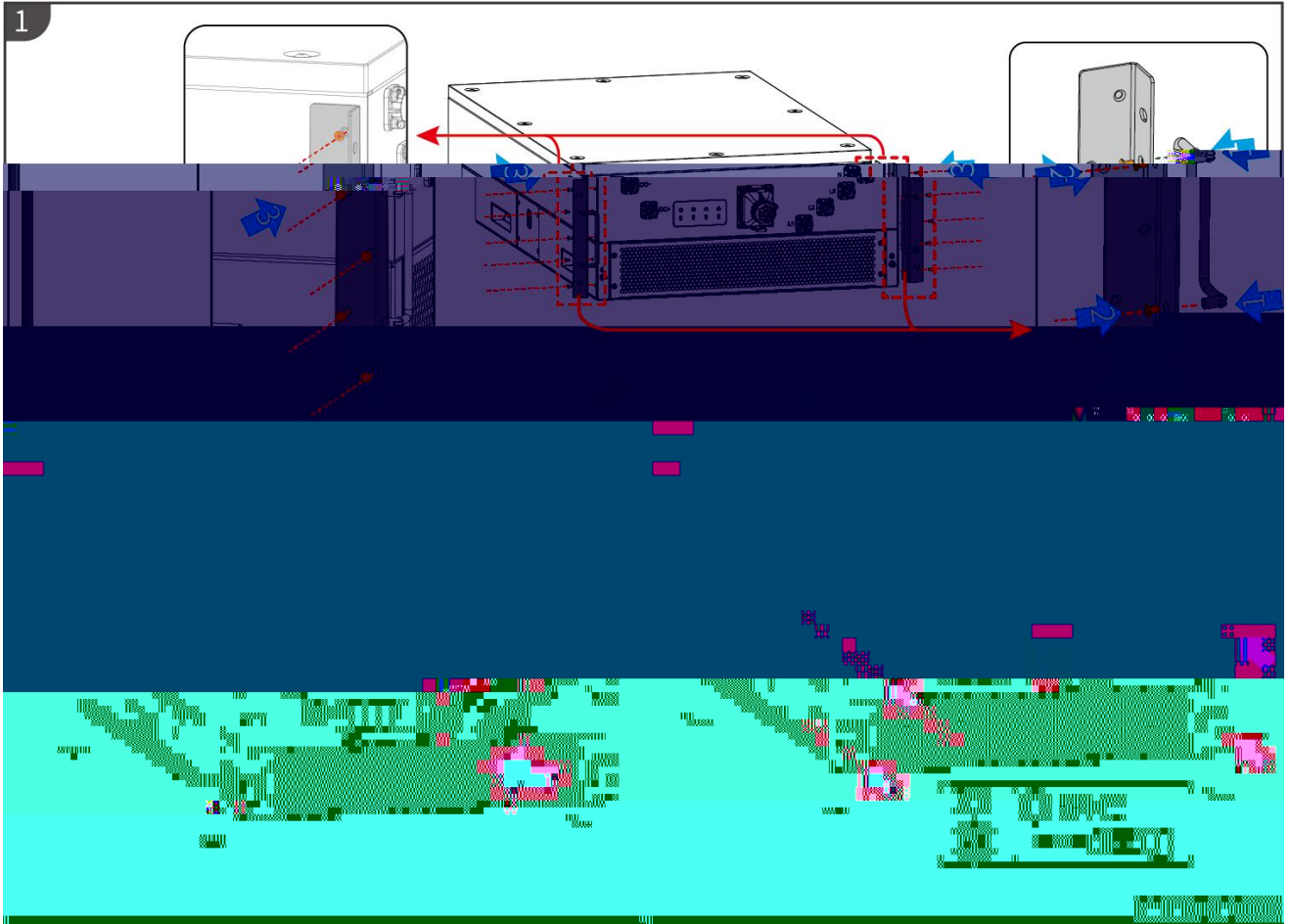



-
-
-
-
-
-



-
-
-
-

-
-
-
-
-
-
-
-

-
-
-
-
-
-



-
-
-

-
-
-
-
-

1

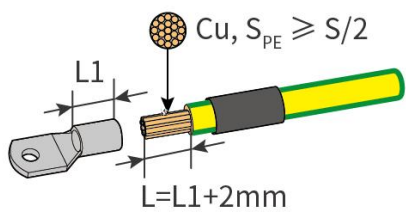

2

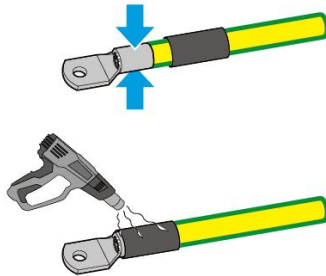

3

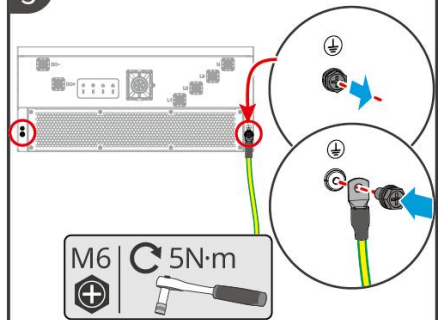

BTH10ELC0001



-
-
-
-



-
-
-
-
-

-
-
-
-



-
-
-

<ul style="list-style-type: none"> • •

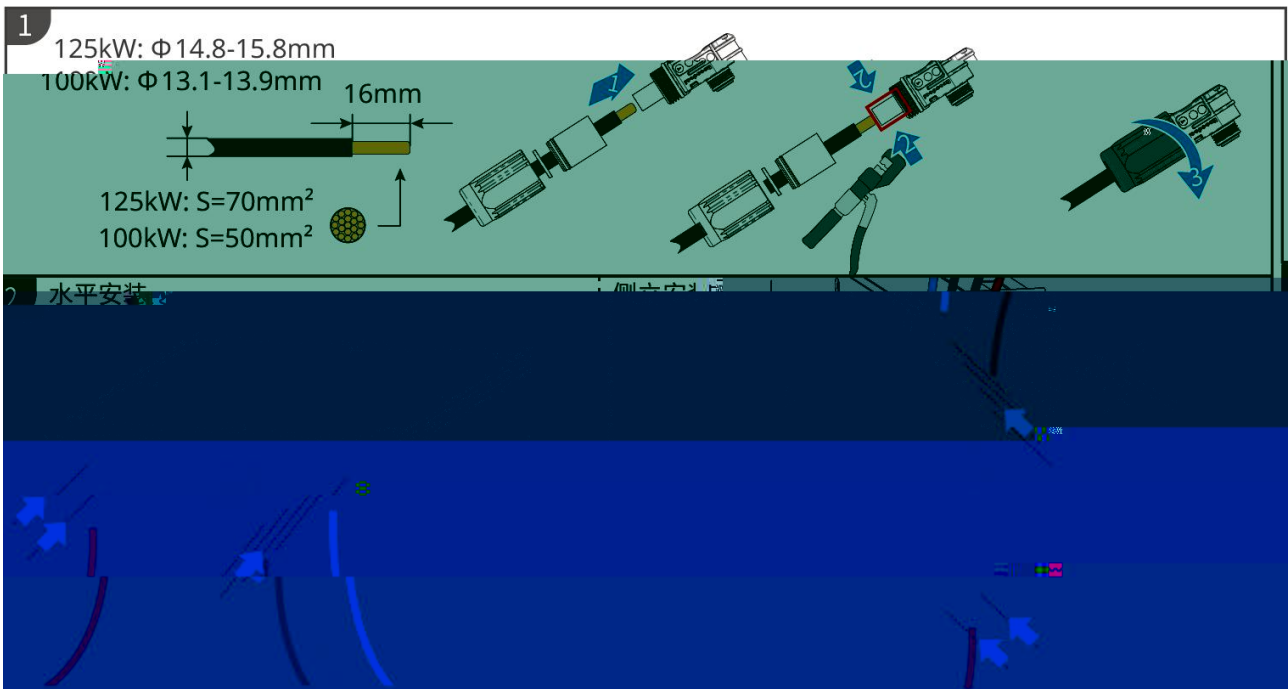

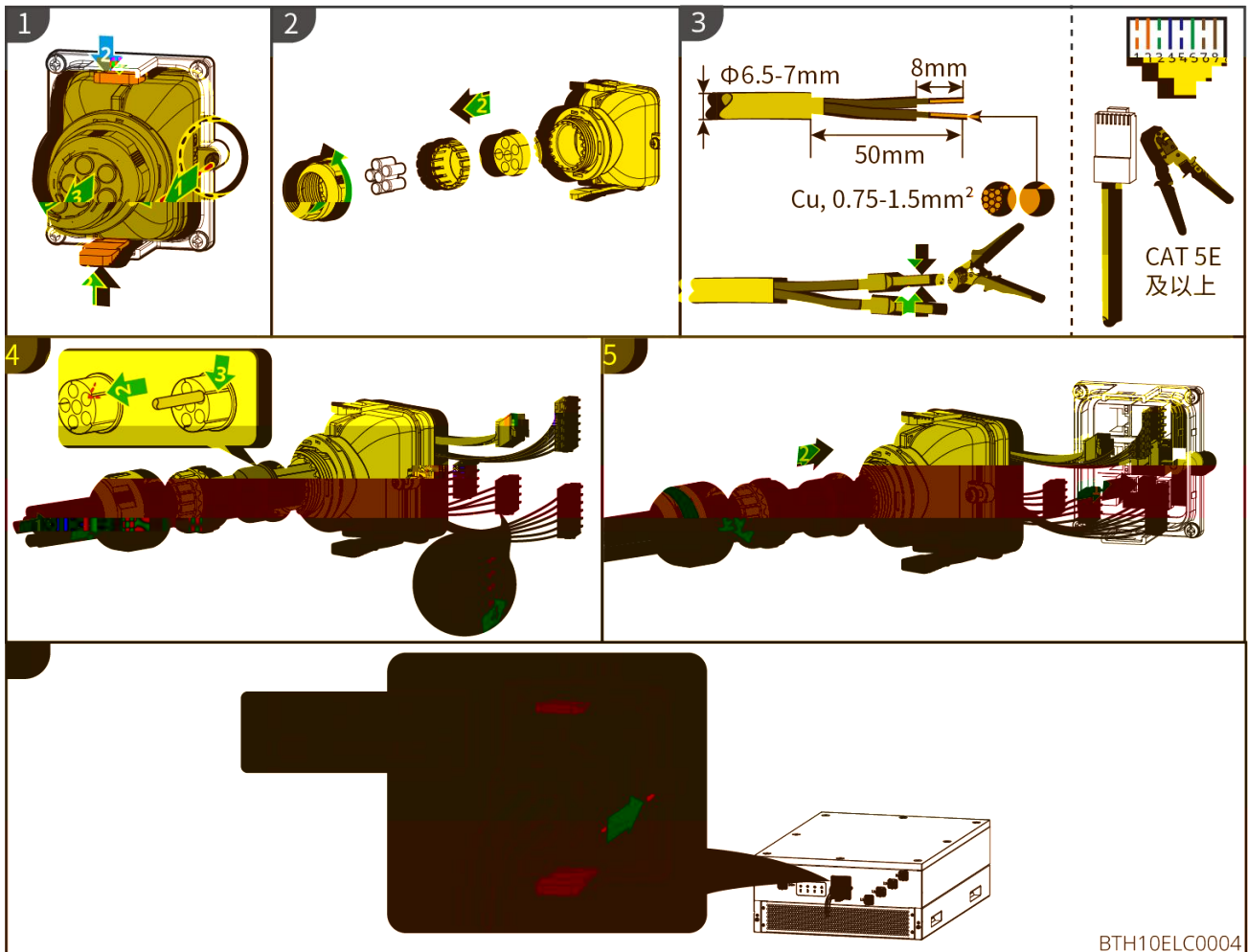

-
-
-

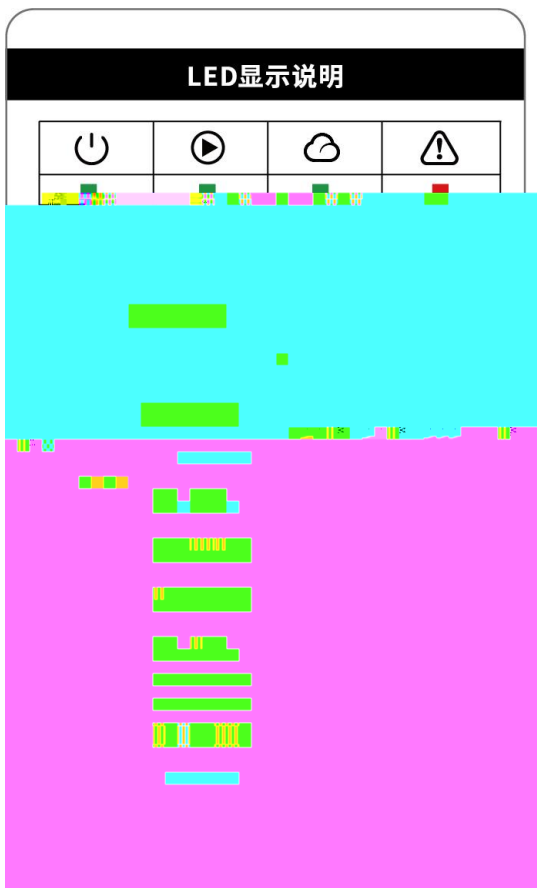
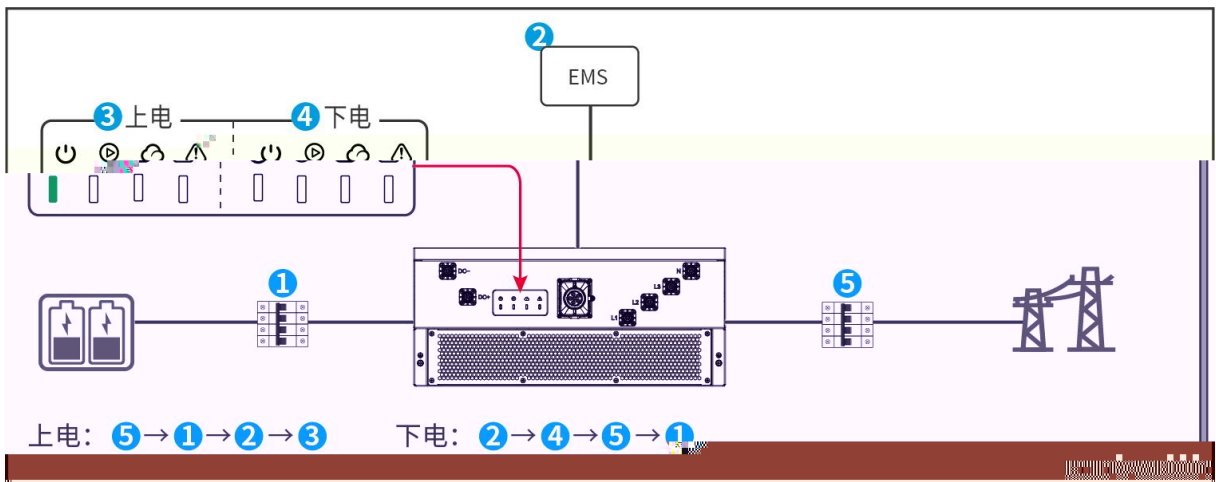



-
-
-
-

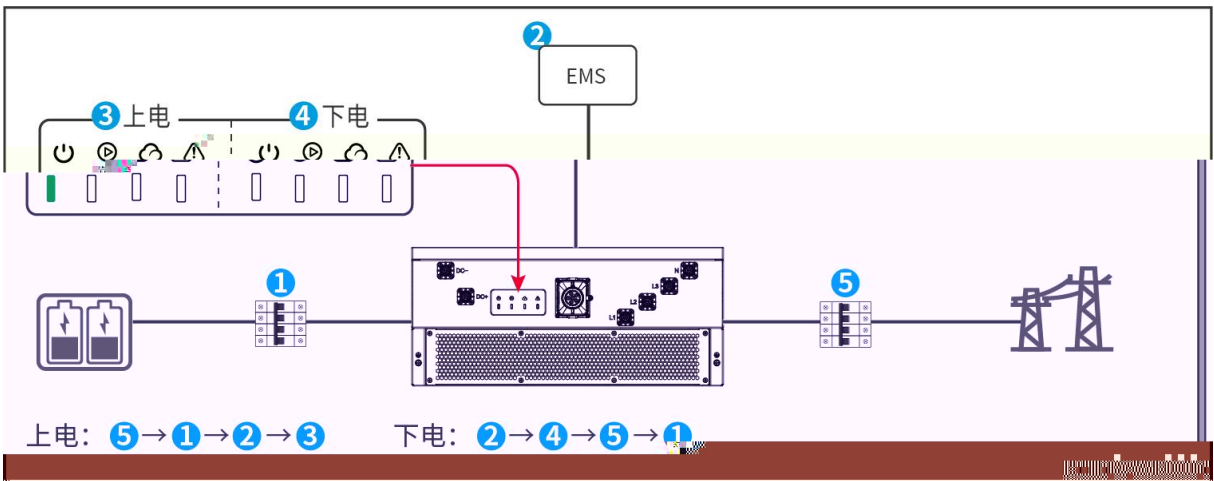



-
-

			1.
			2.
			•
			•
			1.
			2.
			•
			•

1.

2.



σ

			2. • •
			1.



- 如果线缆受损，必须由专业人员进行更换，以避免风险。
- 禁止用水、酒精或油等溶剂清洗设备内部及外部的电气零部件。

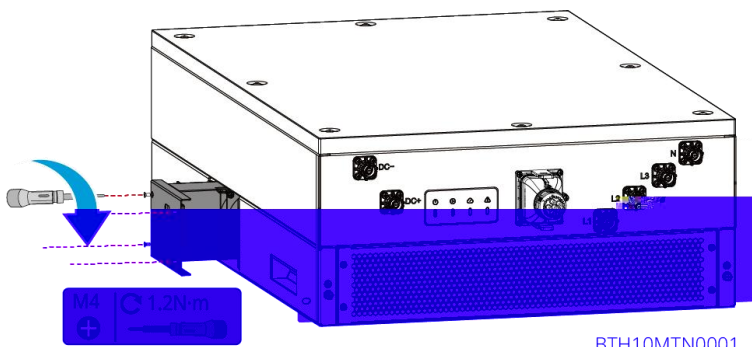

BT10MTN001

