

GOODWE



MS
7-10kW G3

H#z+Z\$" \$&Z##Z\$'

GOODWE
固德威

GOODWE

1 **1**

#z##

#z\$#

#z%\$

2 **3**

\$z#%

\$z\$%

\$z%%

\$z&&

\$z&

7G&

3 **5**

%z#'

%z\$'

%z%'

%z&(

%z#(

%z\$)

%z &"

4 **9**

&z#+

&z\$+

&z%#"

5 **11**

'z###

'z\$#%

'z\$##%

'z\$\$#%

6 **15**

(##'
 (\$#'
 (%#(
 (&#)
 (z\$"
 (z #z\$
 (z \$z\$&

7 **25**

)#\$'
)\$\$'

8 **26**

*#\$(
 *\$\$)
 \$#\$
 *\$\$\$+
 *% G%'
 *& Ea 'Sc9a 3bb%'
 *z%'

9 **31**

+#%#
 +\$%#
 +%%\$
 +&%\$
 +z%9

10 **38**

1

1.1

? E

9)" "" Ž? E Ž5%")" ""	\$\$" H
9 * "" "" Ž? E Ž5%"	* "" ""	\$\$" H
9 # " = Ž? E Ž5%"	# " "" ""	\$\$" H

1.2

1.3

!
!
!

2.4

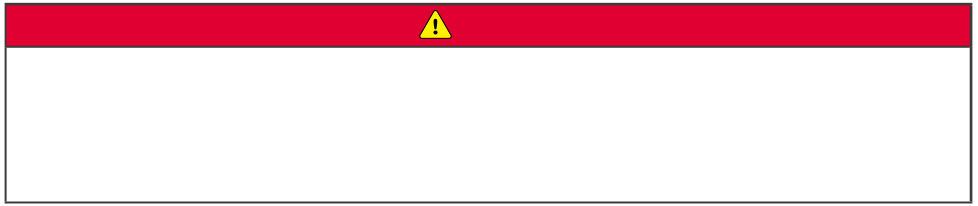

	57		

2.5



2.6 EU

DSV[a 7cg[b_ W f 6[dWf[hW\$" #&! ' % 7G /D76fi
 DWefqUf[a` eaX: SI SdVageEgTefS` Uv6[dWf[hW\$" ##!(' !7G S` V /7Gfi\$" #' !*(%Da: Efi
 I SefW7^Wfcd[US^S` V 7^Wfcd: [U7cg[b_ W f \$" #! #+! 7G
 DW[efcdSf[a` t 7hS'gSf[a` t 3gfZad! Sf[a` S` V DWefqUf[a` aX5ZW_ [US'e/75fi@a #+)]!\$" (/D735: fi

7^Wfcd_ SY` W[Ua_ bSf[T[1fk 6[dWf[hW\$" #&! % !7G /? 5fi
 7^Wfcd[US^3bbScSfge >ai Ha fSYW6[dWf[hW\$" #&! % !7G />H6fi
 DWefqUf[a` eaX: SI SdVageEgTefS` Uv6[dWf[hW\$" ##!(' !7G S` V /7Gfi\$" #' !*(%Da: Efi
 I SefW7^Wfcd[US^S` V 7^Wfcd: [U7cg[b_ W f \$" #! #+! 7G
 DW[efcdSf[a` t 7hS'gSf[a` t 3gfZad! Sf[a` S` V DWefqUf[a` aX5ZW_ [US'e/75fi@a #+)]!\$" (/D735: fi
 7G _____ ž

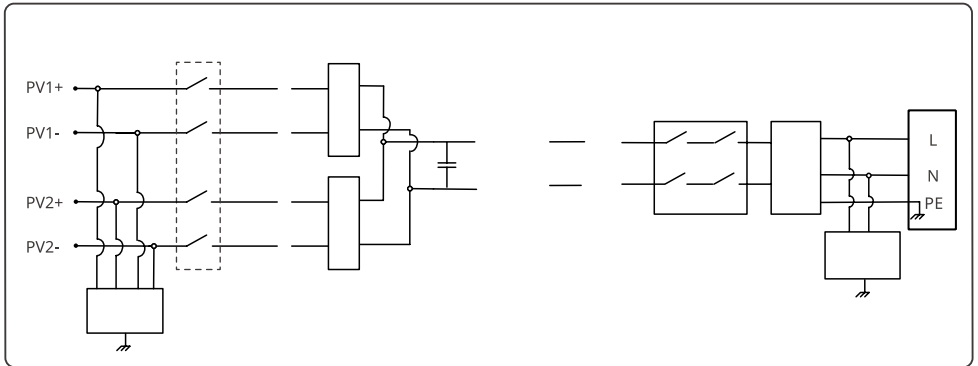

3.4

3.4.1

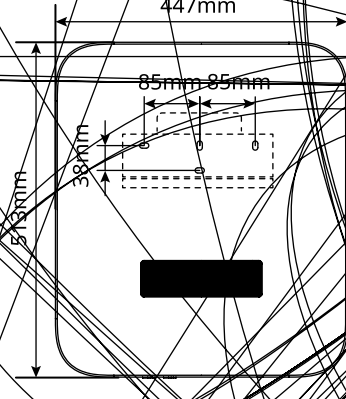
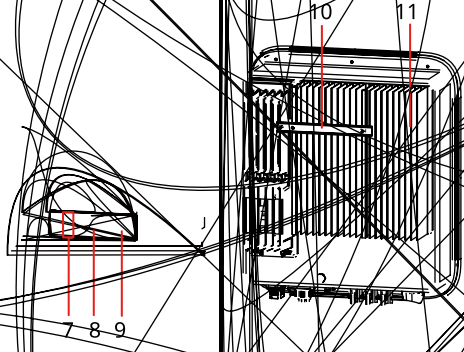
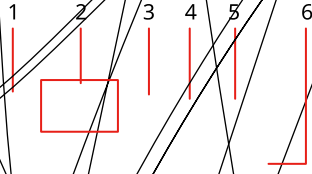

	BH		5BDE 80
%	GE4		
∇	DE&*'		
8	BF	DE&*' 5 6D761	
(
	11		

+	/ fi	
#"		
##		

3.4.2

⏻		
		!
		DE&*'
▶		
⚠		

⏻		
▶		
☁ E7? E		
		DE&*'
⚠		

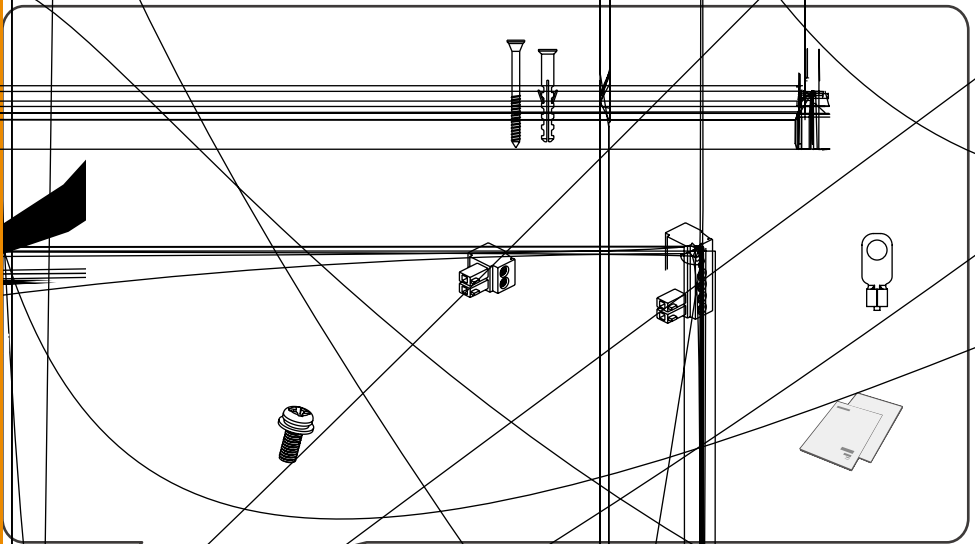

AF

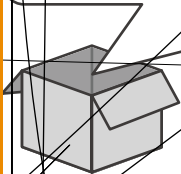

Handwritten marks and symbols at the bottom left corner.

4.3

#ž

\$ž

%ž

&ž

' ž

(ž

(

)ž

(

(

" " " _
fi

fi /

% ' ? : |

7 ? ;

% _

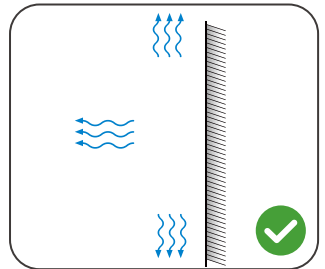
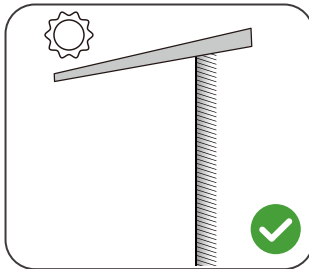
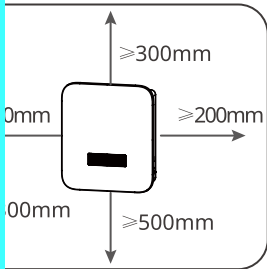
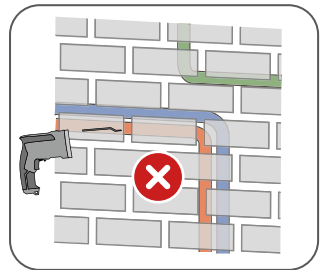

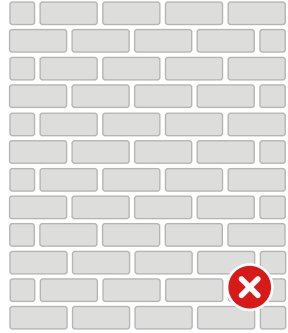
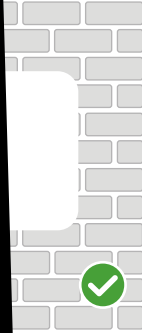

5.2

5.2.1

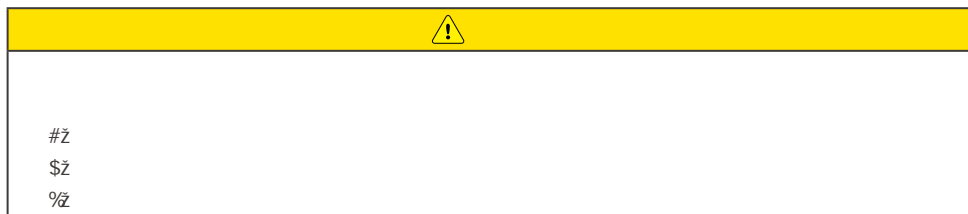

5.2.2

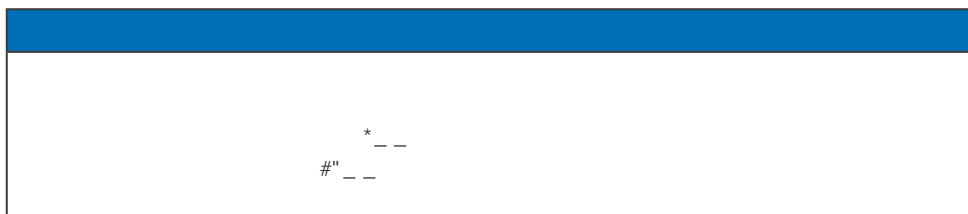

1

2

3

4

* _ _

*" _ _

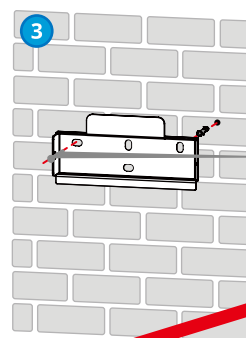
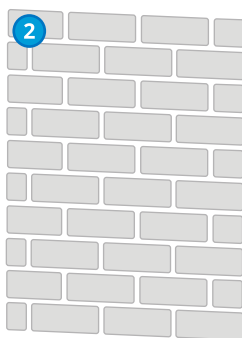
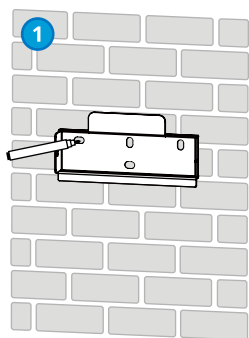

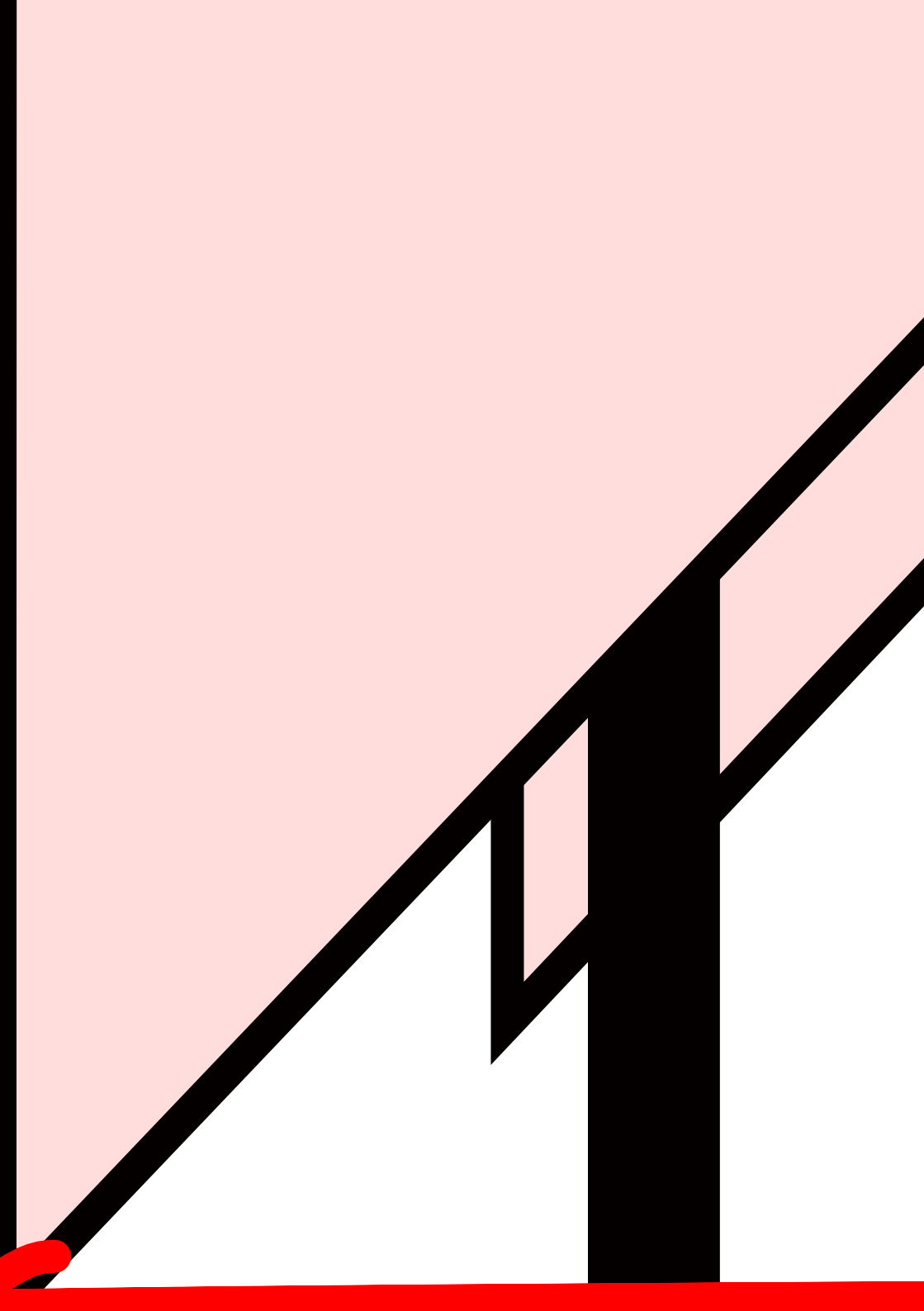

6

6.1

Warning icon: 

-
-

-
-
-

6.2

Warning icon: 

ŠZ(_ _ s

†



6.3



PV			
1	MPPT		
2	PV	PV+ PV	PV-



	BH	? BBF	BH	BH
	BH	(" " H		
	? BBF			
9I) " " " Z / E Z %	9I * " " " Z E Z %		\$ " " H	
9I # " = Z / E Z %	# " " H			
? BBF			? BBF	
BH		? BBF		
BH	BH		BH	
&Z(_ _ \$ HSUa`				

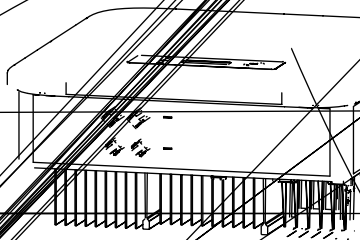

- 1
- 2
- 3
- 4
- 5

91) "" "Ž? EŽ5%	' " 3
91 * "" "Ž? EŽ5%	' " 3
91 # " =Ž? EŽ5%	(%3

3 B56

56

	RCD
91) "" "Ž? EŽ5%	% " 3
91 * "" "Ž? EŽ5%	
91 # " =Ž? EŽ5%	



> @ B7

AC-2

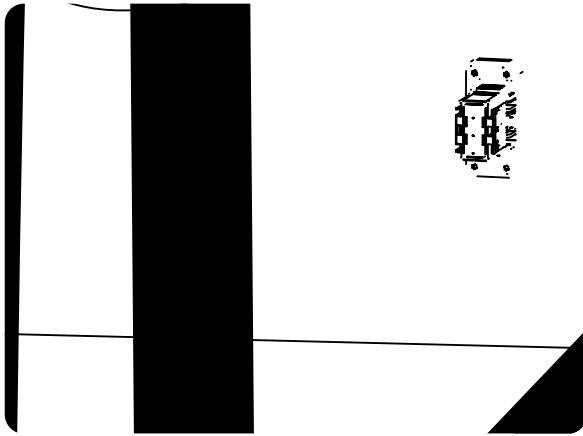

6.5

5F

f #.

f \$.



: a_ W# [f

5F

I [8] >3@

\$&:

: =#" " "

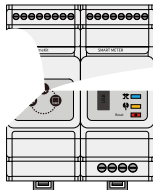

: =#" " "

6.5.1



DE&*'	DE&*'	#, DE&*' Ž \$, DE&*' Ł	
fi	DE6	% DW afWEZgfVai ` !7BA Ž & DW afWEZgfVai ` !7BA Ł	
	;!A	' (, ;!A %) , ;!A \$Ž , ;!A \$Ł +, ;!A #Ž #" , ;!A #Ł	
	? WVVd	##, ? WVVŽ #\$, ? WVVŁ	5F
5F	5F	##, 5FŽ #&, 5FŁ	
6D76	6D76	#, 5A? !6D? " #(, D7897@ #), 6D? &! * #*, 6D? %! #+, 6D? \$!(#", 6D? #!'	6D76



6.5.2

9BDE &9

74

9BDE &9 | f 4 g WaafZ - f

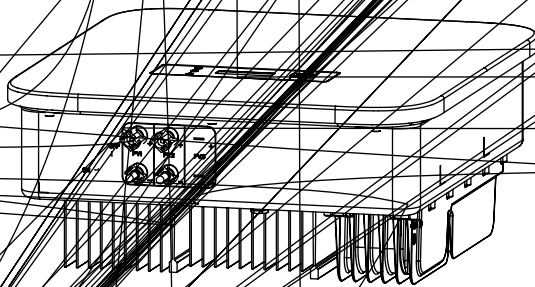

.1

#	
\$	
%	
&	
,	

.2

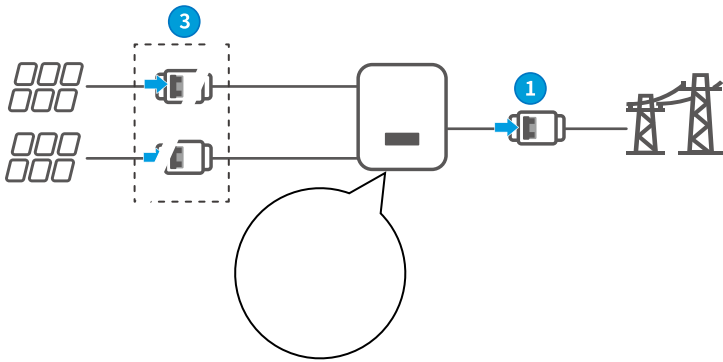

8

8.1

⏻		
▶		
		DE&*'
!		

8.2

•	V1.00.00	V1.00
•		
•		

>56

\$)

8.2.1

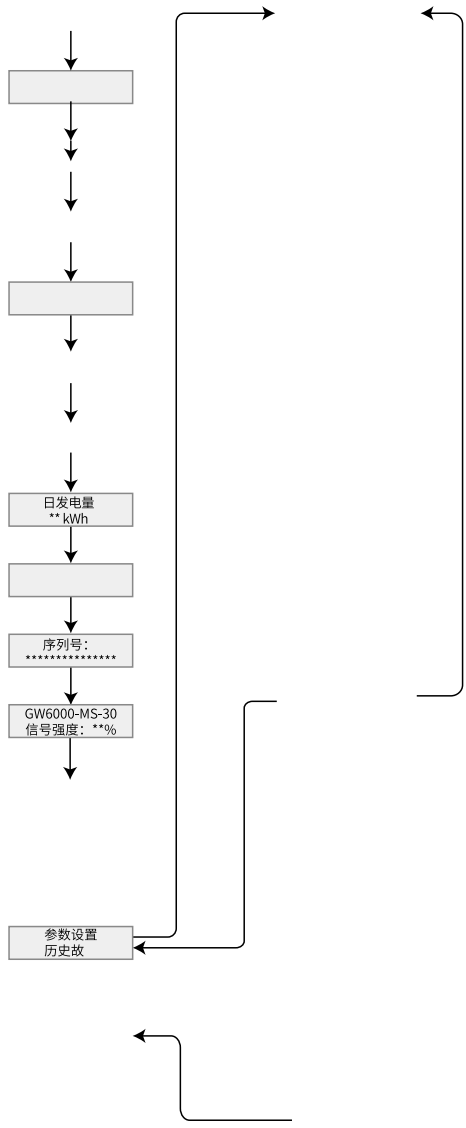

8.2.2

/ " 2	
	!
9) " " " ? E 5 % + " .	
	3D?
	!
	!
! >	
! >	
? aVTge	? aVTge
;EA	BH 7 ;EA
BH#	BH
BH\$	

Eg` ebWU	Eg` ebWU

8.3 U

- 1
- 2 G
- 3 G GE4

8.4 SolarGo App

Ea`Sd9a 3bb I [8[9BDE

- #Z
- \$Z
- %Z

Ea`Sd9a 3BB [Zffbe,!W YaaVi WUa !8fb!7@!6ai `aSVe!](#)
[GeWl \\$" ? S` gS!9! CEa`Sd9aCGeWl \\$" ? S` gS!Z!@zVX](#)



Ea`Sd9a 3bb



Ea`Sd9a

8.5

I [8[>3@ &9 9BDE

- #Z
- \$Z
- %Z



3bb

%!

9

9.1

- 1
- 2
- 3

9.2

- 1
- 2
- 3
- 4

9.3

!

9.4

#ž

\$ž

%ž

#		#ž \$ž	#ž \$ž
\$			#ž \$ž : HDF %ž
%			#ž \$ž

&			#ž \$ž %ž >HDF
,	#" _ [#" _ [#ž \$ž
(#ž \$ž
)			#ž \$ž

*			#ž \$ž
+			#ž \$ž
#"		>HDF	#ž \$ž
##		: HDF	
#\$	%" _ 39XU[#ž \$ž
#%	(" _ 39XU[
#&	#" " _ 39XU[
#'	9XU[
#(65;		#ž \$ž
#)	65;		
#*		#ž \$ž	#ž \$ž %ž ' "] ' "]

#+		#ž \$ž > @	#ž \$ž > @
\$"			#ž \$ž
\$#		#ž \$ž %ž US` Tge &ž 5D5 ' ž (ž	
\$\$			
\$%			
\$&		#ž \$ž %ž	
\$'		#ž \$ž / fi %ž	

\$(8'SeZ	8'SeZ	
\$)		#ž \$ž	
\$*			
\$+		#ž \$ž (") %ž	#ž \$ž %ž
%'		#ž BH \$ž 4GE	
%#	BH		
%\$	BH	#ž \$ž	
%%	BH	#ž \$ž	
%&	Efđ Y#		
%	Efđ Y\$	BH	BH# BH\$

9.5



	!	# ! p# !
	#"	# !
		# ! p# !
		# !

		ž
B;6		ž
		ž
		žš' p("
		"p#" "
-		&" "
		>7ł >56 ll >3@ł3BB
	DE&*' ł&9ll [8[>3@	DE&*' ł &9
=Y		#* ž'
° ° --		&&) ° ' #° \$"'
V4		%
l		. #
		;B((
		5&
	? 5&/\$ž p&_ _ \$fi	
	35	
		&=&
		;;
		65 ;; ! 35 ;;
		;
		BH 5 35 5 5A? 3
		\$'



F, &" Ž++* Ž#\$#\$

i i i ŽYaaVi Vūla_

eVth[UM2 YaaVi Vūla_

